

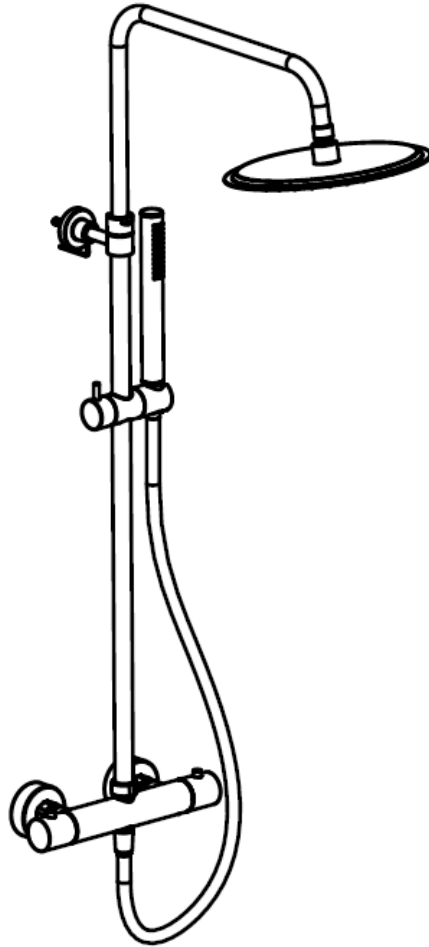

**SAT**

**SATDASSTKBZ  
SATDASSTK**





**SATDASSTK**  
**SATDASSTKBZ**

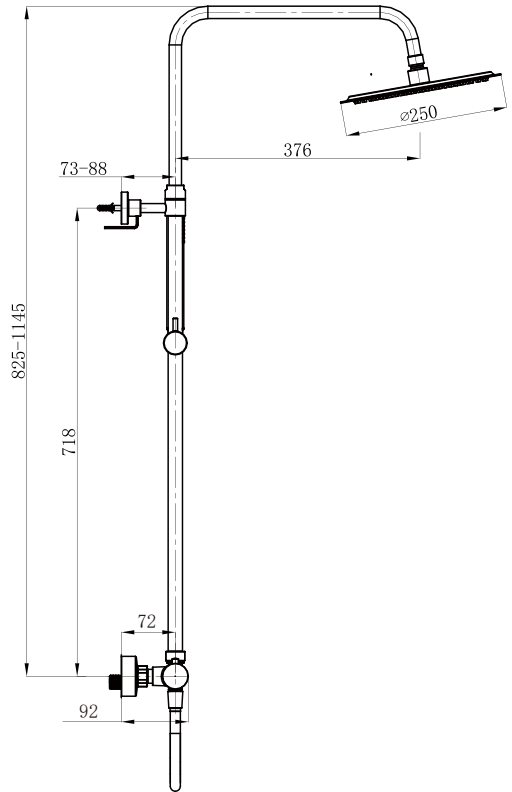
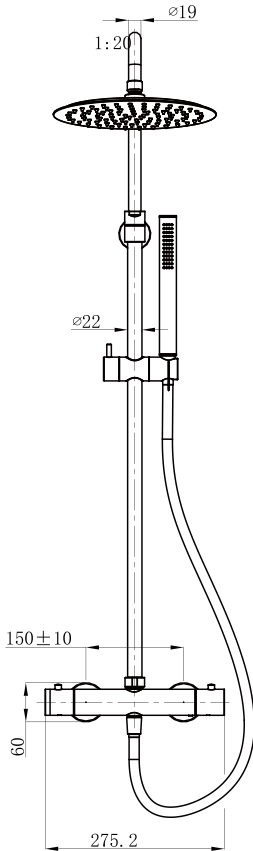
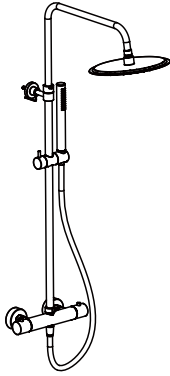



SATDASSTK  
SATDASSTKBZ

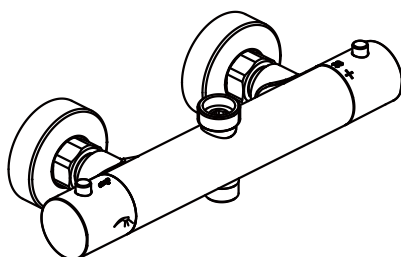
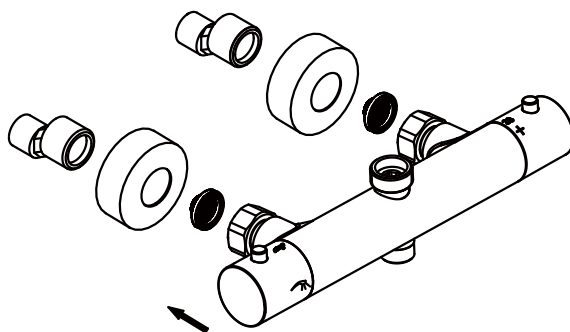
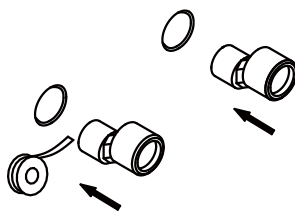
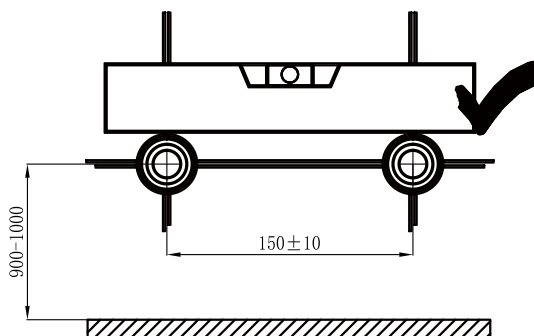



**SATDASSTK**  
**SATDASSTKBZ**

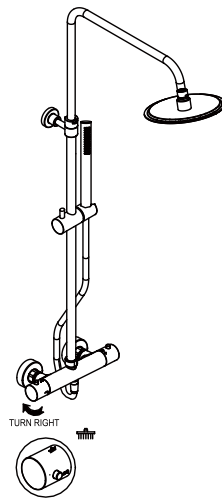
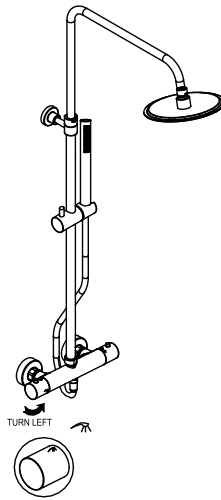
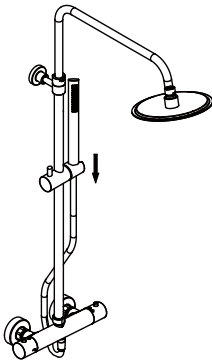
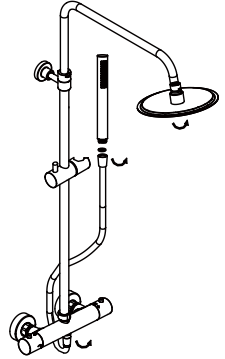
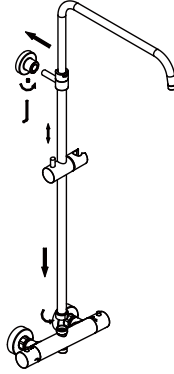
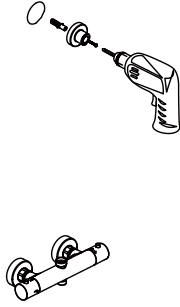
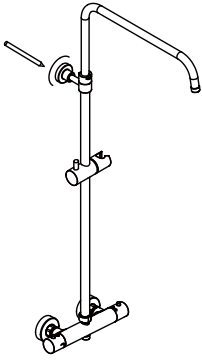



**SATDASSTK**  
**SATDASSTKBZ**

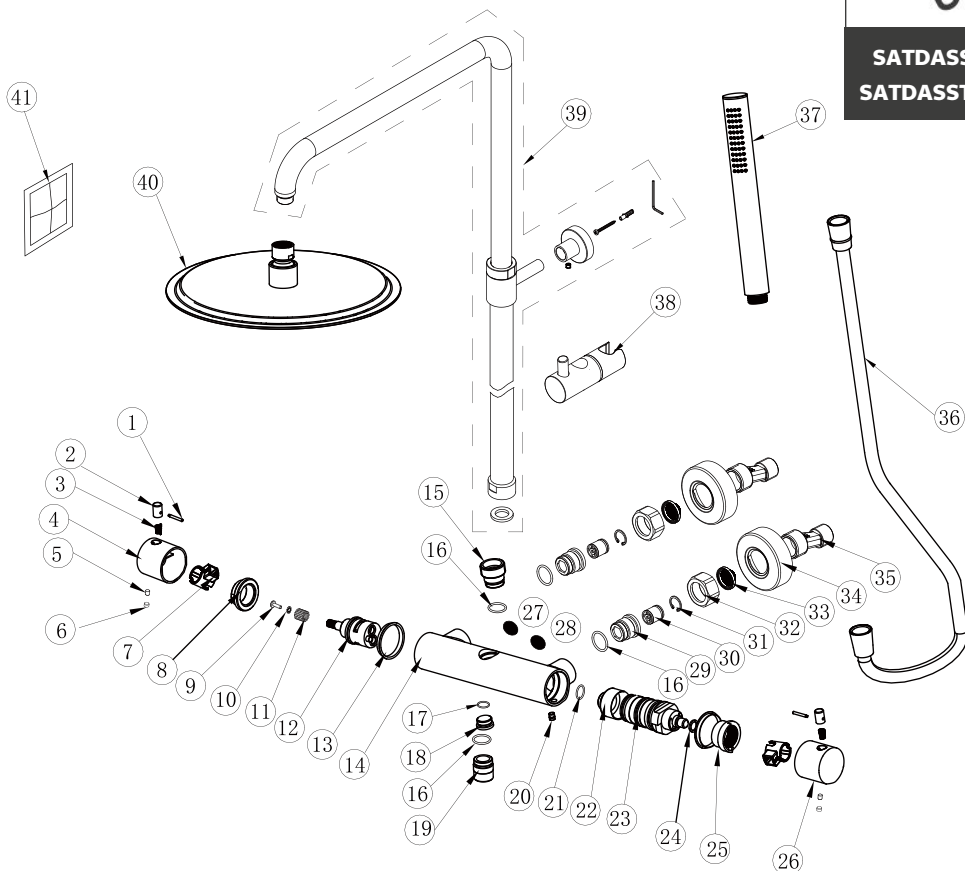

<b>SATDASSTK</b>		<b>SATDASSTKBZ</b>	
1-7	NDSATDASSTKPAKA1	1-7	NDSATDASSTKPAKA1BZ
12	NDSIKOBSTKART4	12	NDSIKOBSTKART4
23	NDSIKOBSTKART	23	NDSIKOBSTKART
26	NDSATDASSTKPAKA2	26	NDSATDASSTKPAKA2BZ
21-26, 42	NDSATDASSTKPAKA	21-26, 42	NDSATDASSTKPAKABZ
16, 27-35	NDSATDASSTKETAZKA	16, 27-35	NDSATDASSTKETAZKAZ
36	SATBSPDA	36	SATBSPDABZ
37	SATBSRSDA	37	SATBSRSDABZ
38	NDSATDASSTKJZDEC	38	NDSATDASSTKJZDECZ
40	NDSATSSTKHLAV	40	NDSATSSTKHLAVBZ

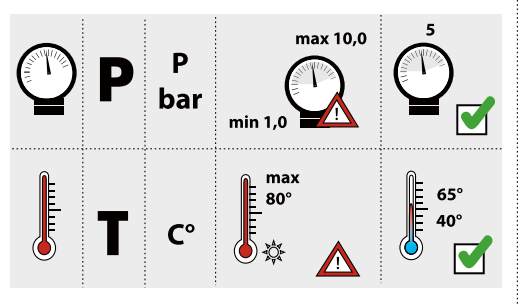
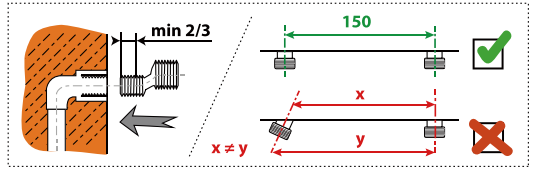
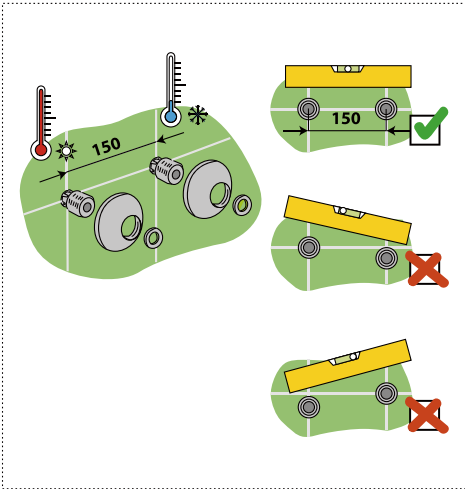
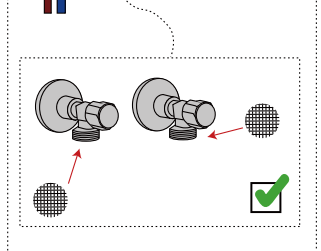
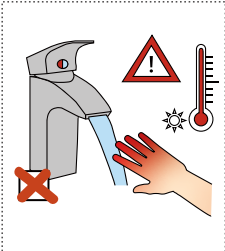
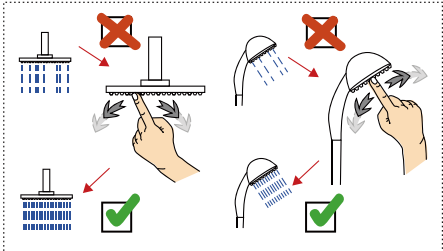
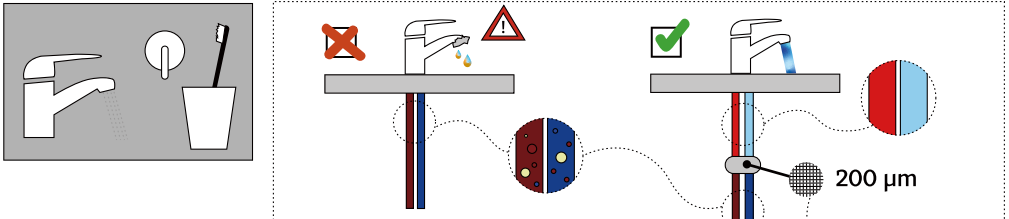
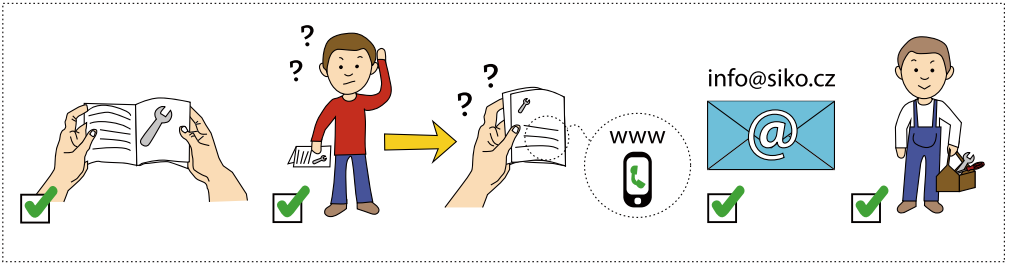

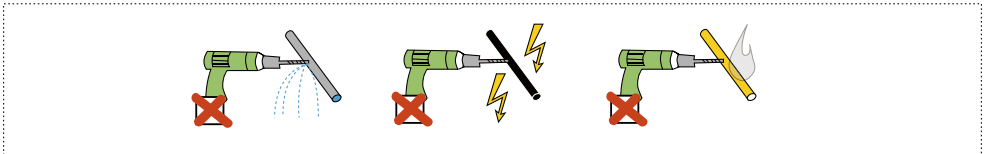
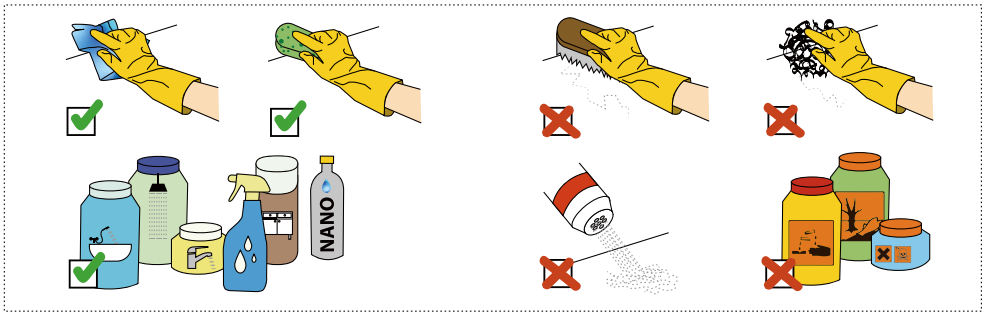
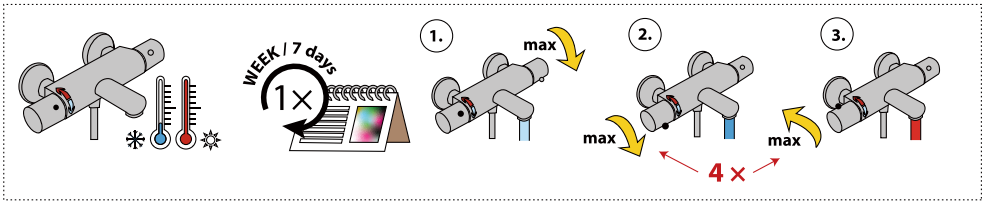

SAT<sup>®</sup> is registered trademark of



**Swiss  
Aqua  
Technologies**

**Swiss Aqua Technologies AG**  
Gewerbstrasse 9, 6330 Cham, Switzerland  
[www.swatec.ch](http://www.swatec.ch)  
Imported by SIKO KOUPELNY a.s.  
Made in P.R.C.