

	R146DY004	R146DY005
H	325	325
H1	135	135
H2	190	190
G	3/4"	1"
I	180	200

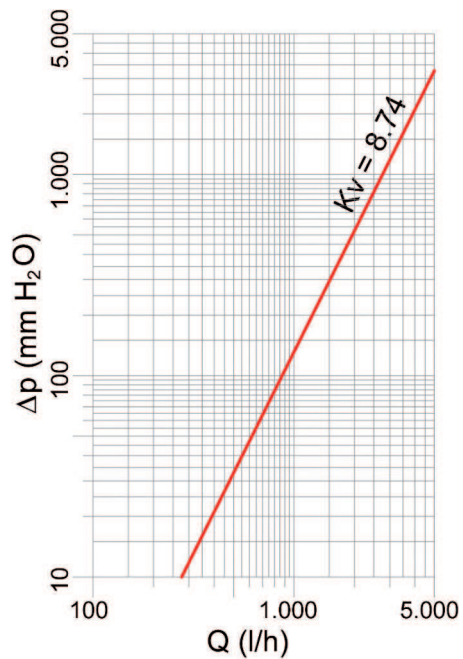

GIACOMINI
Technology in Comfort



R146D



max. 110°C



max. 10 bar

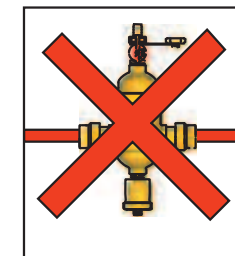
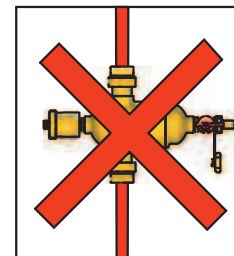
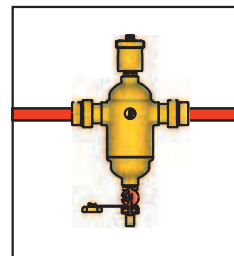
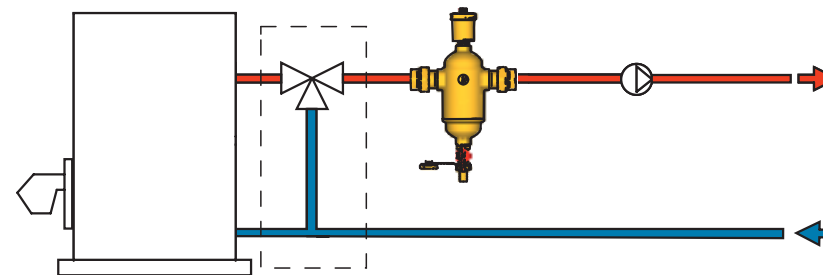

047U51968

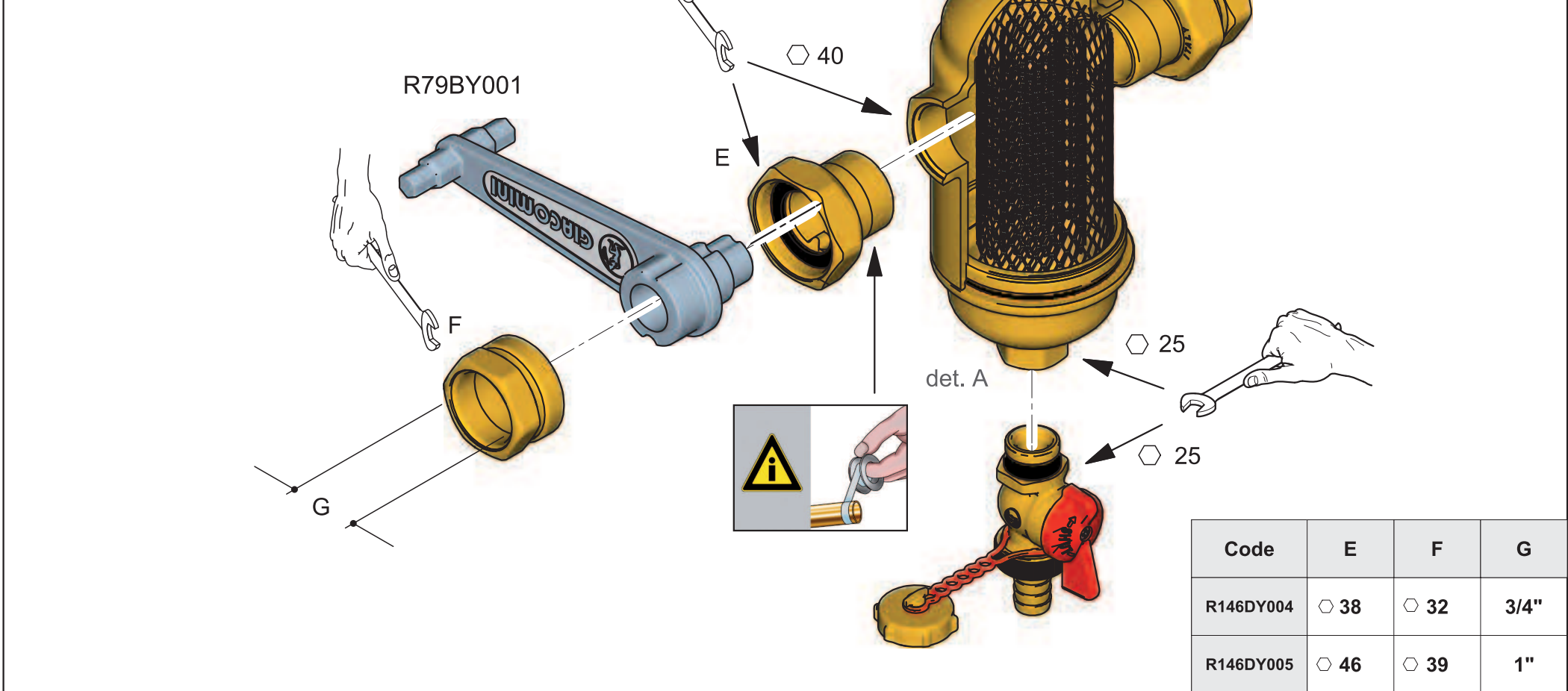
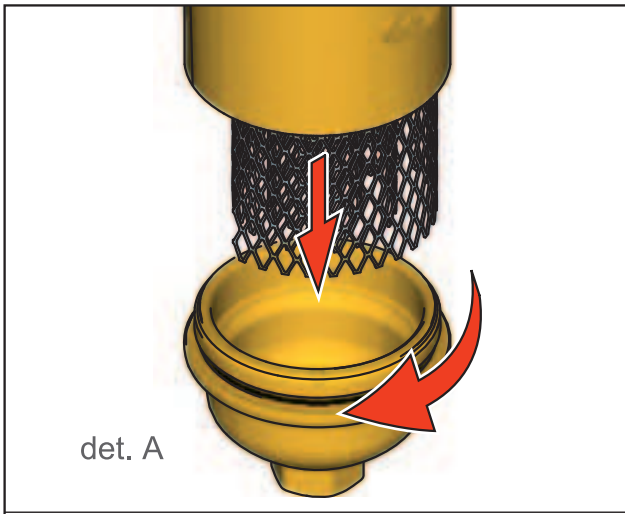

Code	E	F	G
R146DY004	○ 38	○ 32	3/4"
R146DY005	○ 46	○ 39	1"